

Composite Balustrades installation guide 2021

Composite balustrades by SAiGE are easy to install whilst offering a long-lasting and stylish solution.

Please ensure Installation is followed as per the Installation Guides for SAiGE's warranty to apply. For any clarification or information please contact a member of the SAiGE Team on 01789 721 576 or email info@saigedecking.com

HIGH STRENGTH

HIGH SPECIFICATION

BRITISH DESIGN

AWARD WINNING







QUALITY AND TEST CERTIFICATION

100% QUALITY INSPECTION

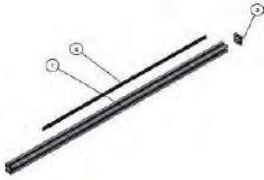
Composite Balustrades by SAiGE

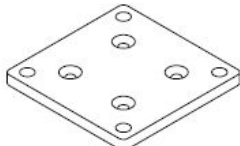
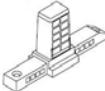
Straight balustrade

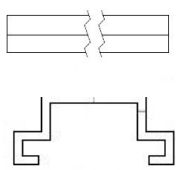
Balustrade Component list

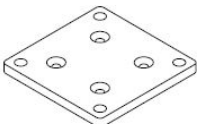
Image	Quantity per bay	Product Description	Dimensions	Weight
Straight Balustrade				28.2kg
	1	1. 1.155m post	70mm x 70mm x 1155mm	3.5kg
	1	2. Post cap		
	2	3. 983mm Insert		
	1	4. 1155mm Insert		
	4	5. 55mm Insert		
	1	Top Handrail	1730mm x 45mm x 45mm	2.4kg
	1	Bottom Rail		
	1	10mm baseplate	130mm x 130mm x 10mm	2.5kg
	4	Bolts to attach baseplate to post		
	4	Concrete fixing bolts		
	26	T Bracket and screws	20mm x 17mm x 36mm	0.035kg e.a.
	11	FSC [®] 100% Composite Spindles	955mm x 50mm x 30mm	1.2kg e.a.
	20	Insert 118.4mm	118.4mm	0.03kg e.a.
	4	55 mm Insert	55mm	0.01kg e.a.
	4	107.5 mm Insert	107.5mm	0.03kg e.a.
Top and Bottom rails come assembled with all T brackets and inserts fitted.				
Additional Finishing post and baseplate				
	1	Additional post kit to finish	70mm x 70mm x 1155mm	3.5kg
	1	Additional baseplate to finish	130mm x 130mm x 10mm	2.5kg

1

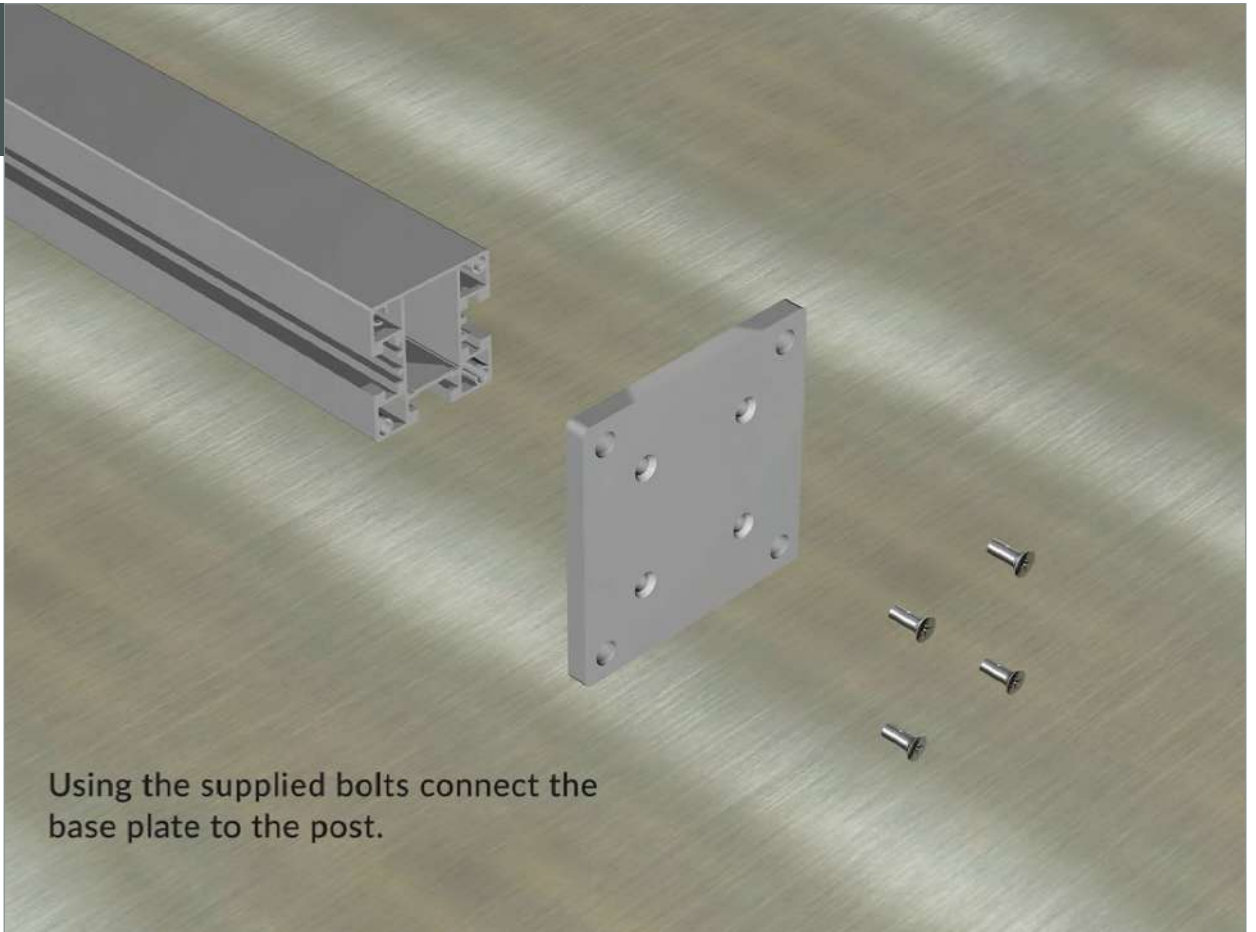

Using the supplied bolts connect the base plate to the post.

2

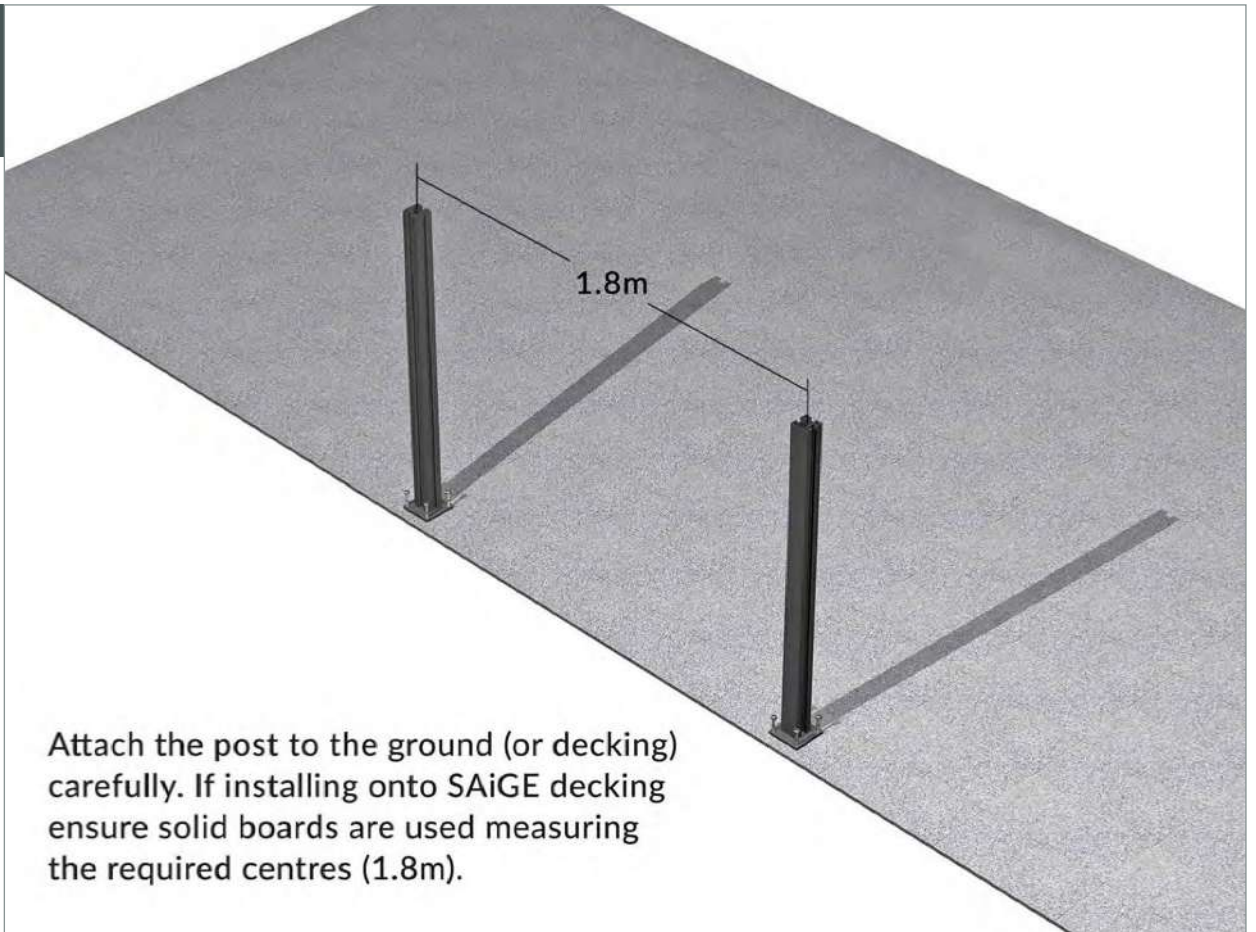

Attach the post to the ground (or decking) carefully. If installing onto SAiGE decking ensure solid boards are used measuring the required centres (1.8m).

3

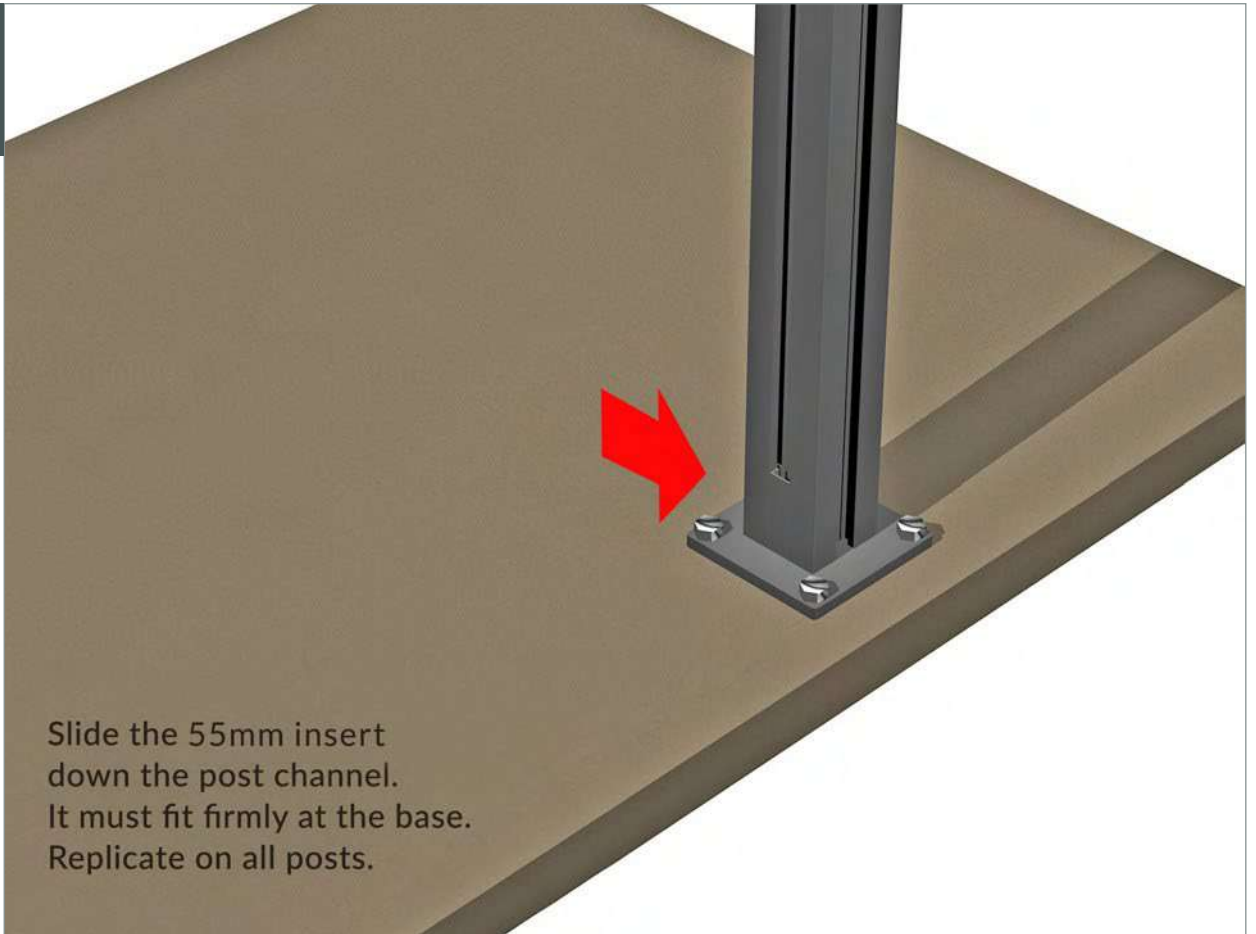

Slide the 55mm insert down the post channel. It must fit firmly at the base. Replicate on all posts.

4

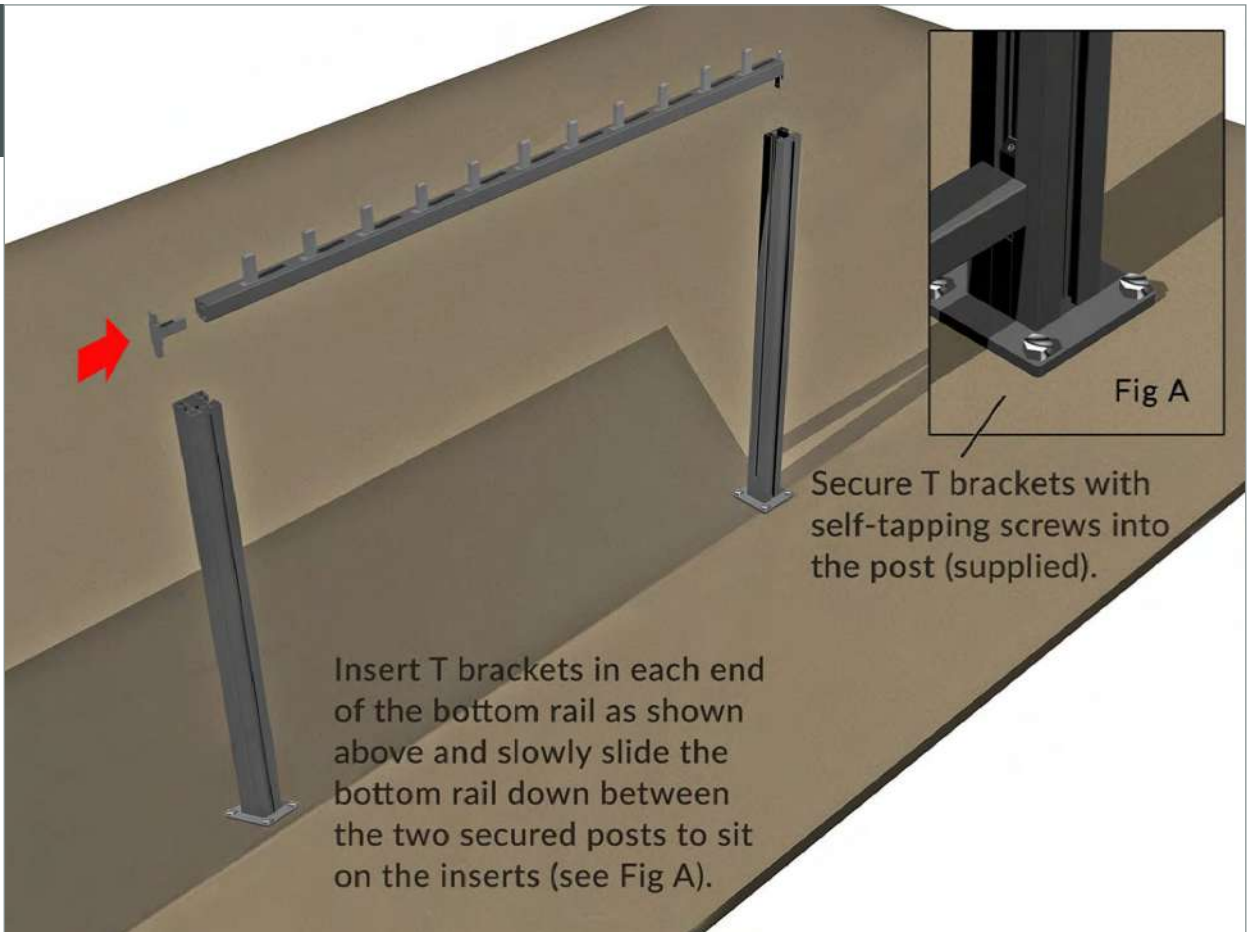

Insert T brackets in each end of the bottom rail as shown above and slowly slide the bottom rail down between the two secured posts to sit on the inserts (see Fig A).

Secure T brackets with self-tapping screws into the post (supplied).

Fig A

5

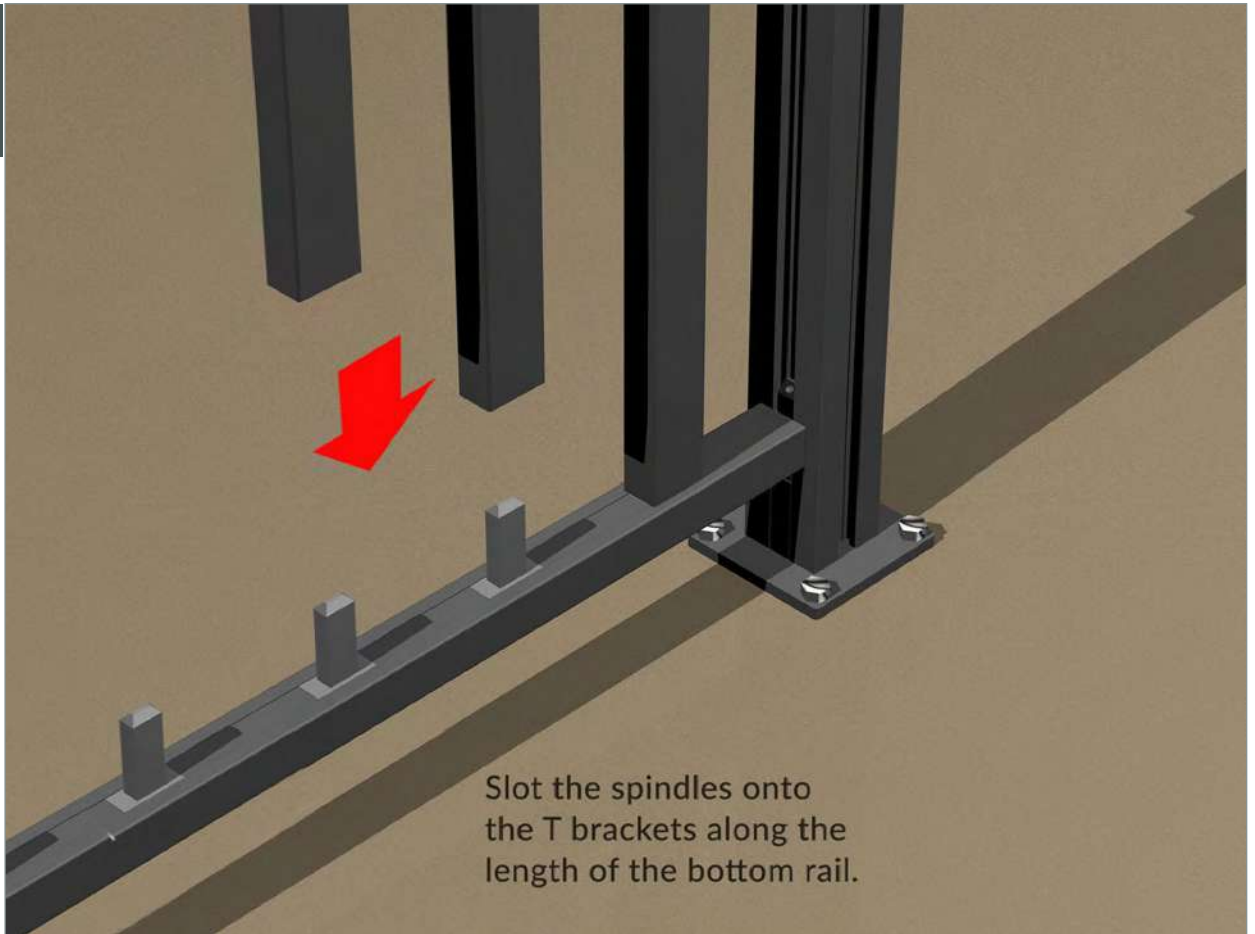

6

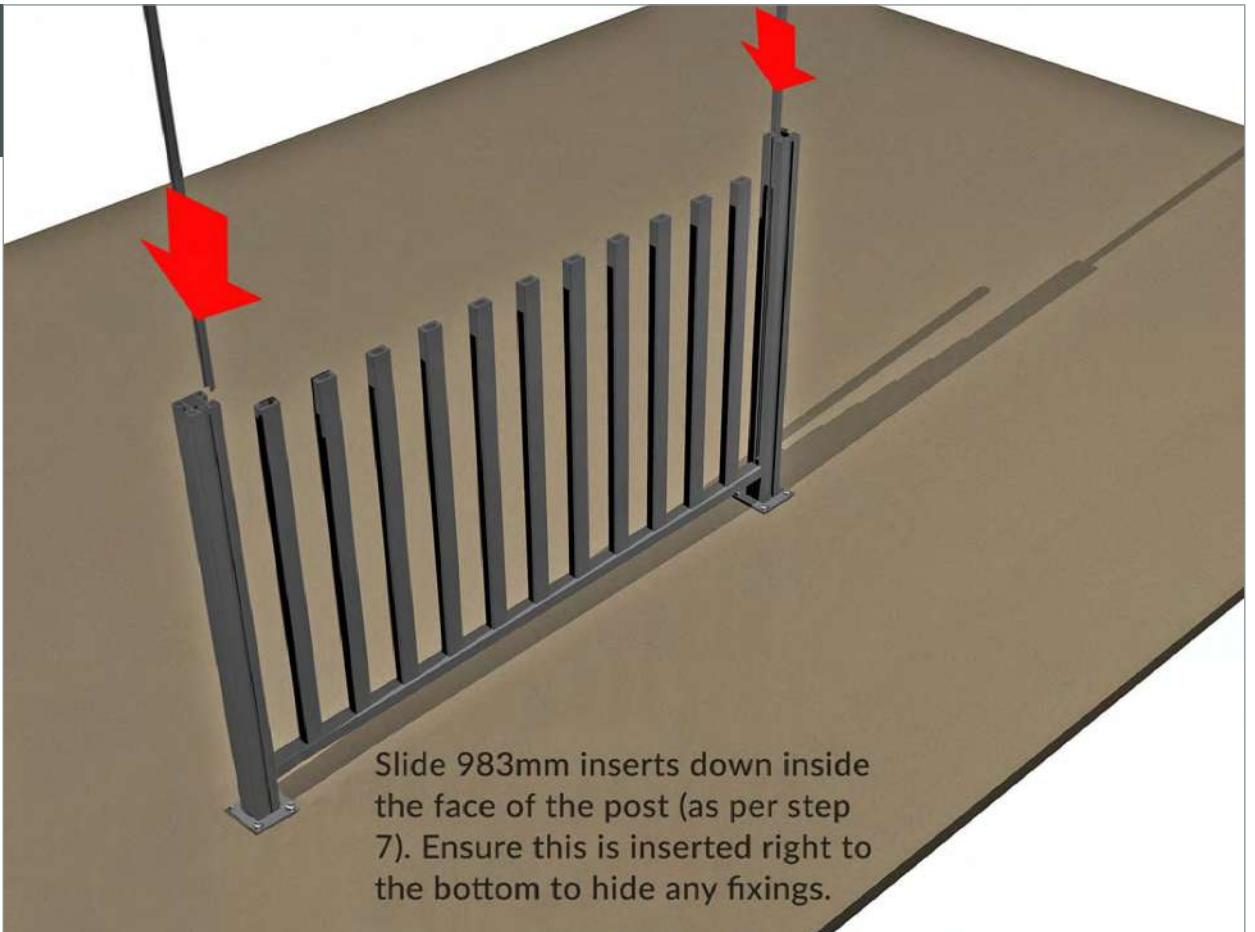

7

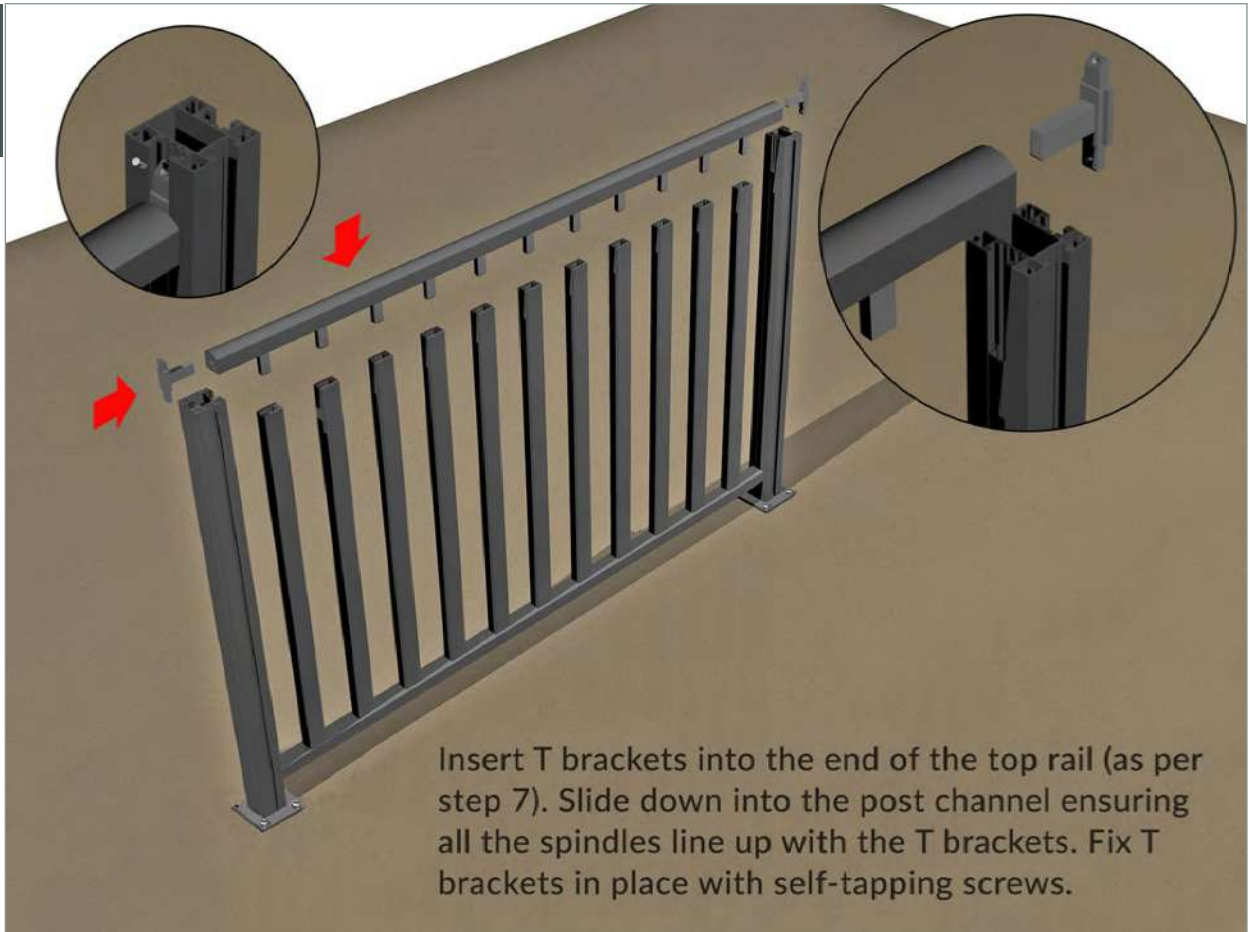

Insert T brackets into the end of the top rail (as per step 7). Slide down into the post channel ensuring all the spindles line up with the T brackets. Fix T brackets in place with self-tapping screws.

8

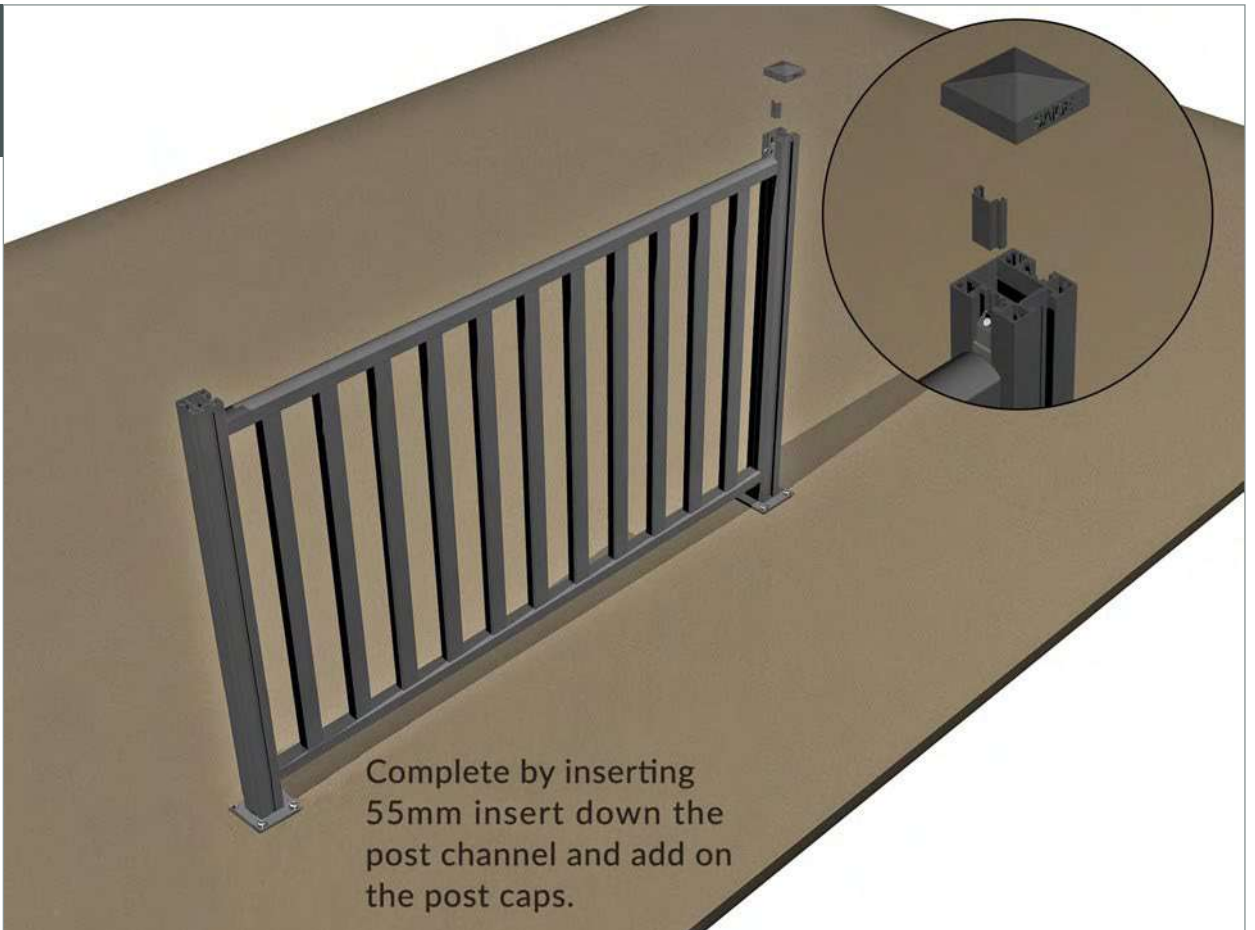



Complete by inserting 55mm insert down the post channel and add on the post caps.

Composite Balustrades by SAiGE

Staircase
balustrade

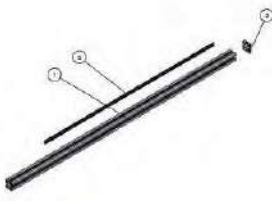
Staircase Balustrade Component list

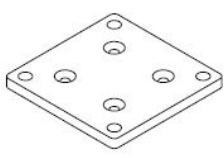
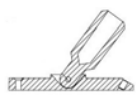
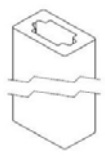
Image	Quantity per bay	Product Description	Dimensions	Weight
Staircase Balustrade				33.61kg
	1	1. 1.2m post	70mm x 70mm x 1200mm	3.7kg
	1	2. Post cap		
	1	3. 983mm insert		
	4	4. 55mm insert		
	2	5. 1.2m insert		
	1	1. 1.155m post	70mm x 70mm x 1155mm	4.1kg
	1	2. post cap		
	4	3. 55mm insert		
	2	4. 983mm insert		
	1	5. 1155mm insert		
	1	Top Rail	1730mm x 45mm x 45mm	2.4kg
	1	Bottom Rail		
	2	10mm baseplates	130mm x 130mm x 10mm	2.5kg
	8	Bolts to attach baseplate to post		
	8	Concrete fixing bolts		
	26	Angled T Bracket and screws	24mm x 17mm x 48mm	0.05kg e.a.
	11	1m FSC [®] 100% Composite Spindles	1000mm x 50mm x 30mm	1.26kg e.a.
Top and Bottom rails come assembled with all T brackets and inserts fitted.				

1

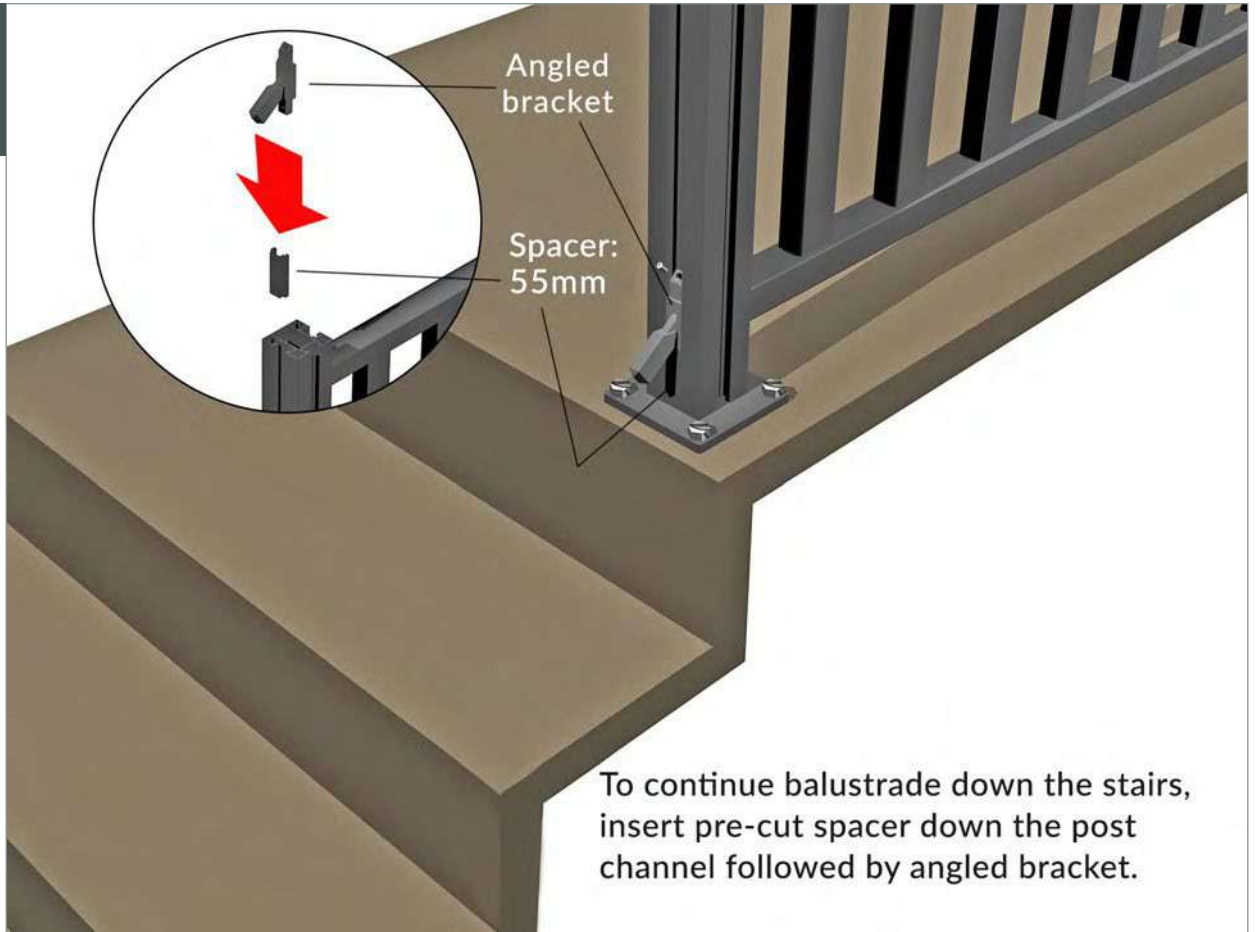

2

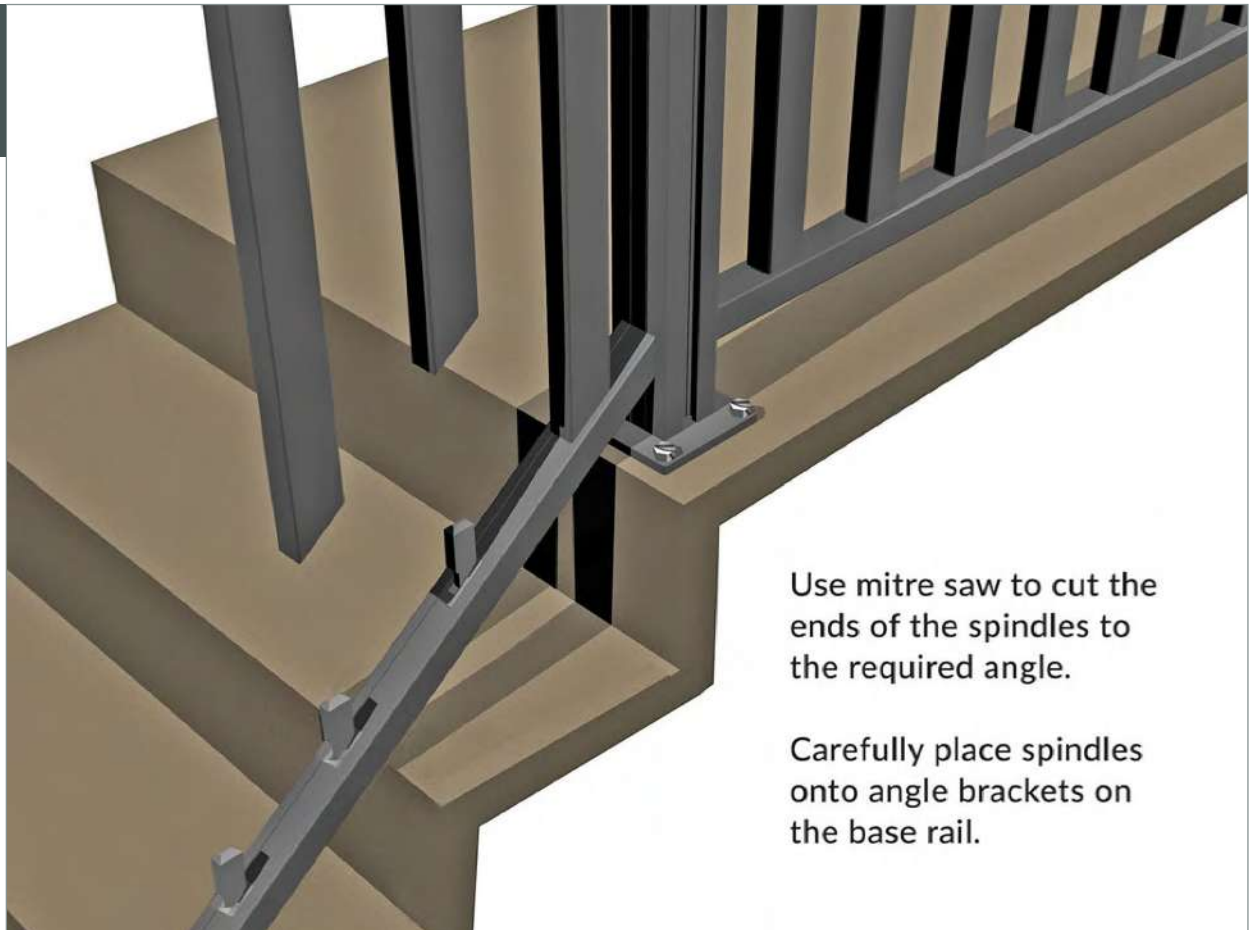

3

Make post B in diagram as Step 1 - but do not fix in place.

Long inserts need to be slid down both posts.

Slide angle T bracket into each end of the handrail, then slide down into posts and onto spindles.

Lock T brackets in place with Allen pins and key.

Fit post B in place.

Fit small inserts and post caps.

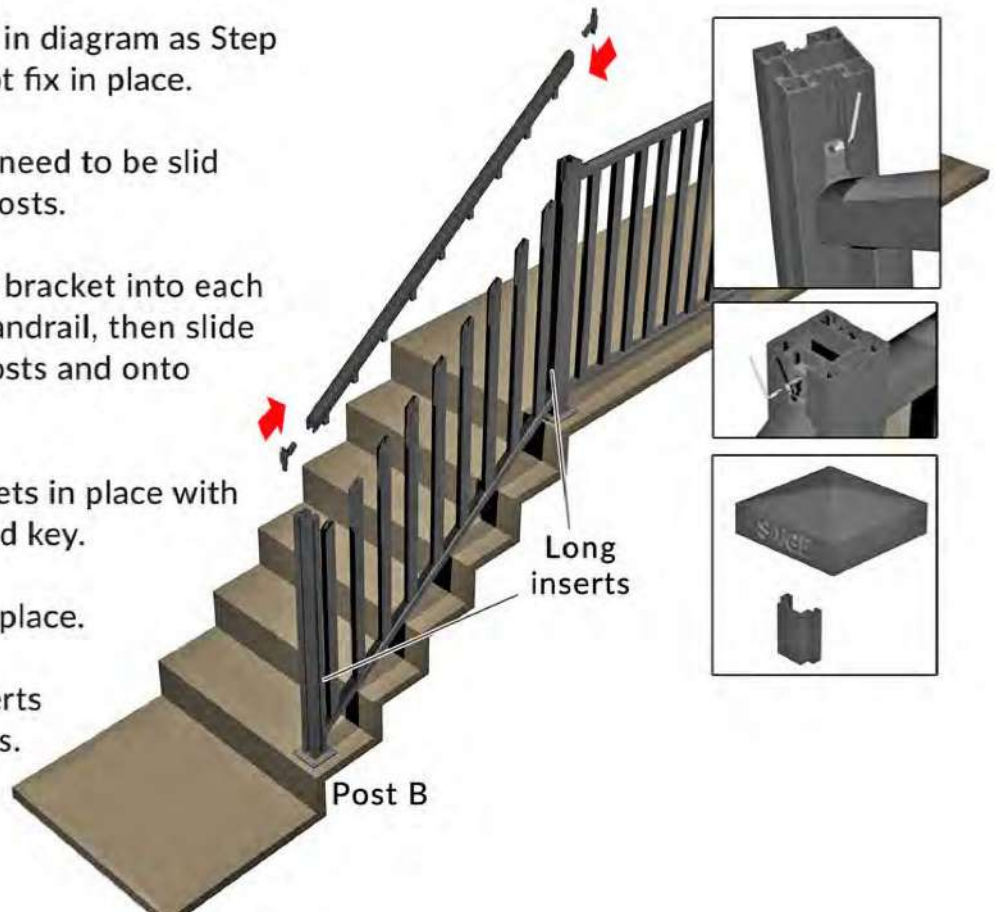

4

Repeat process for any additional balustrade bays.

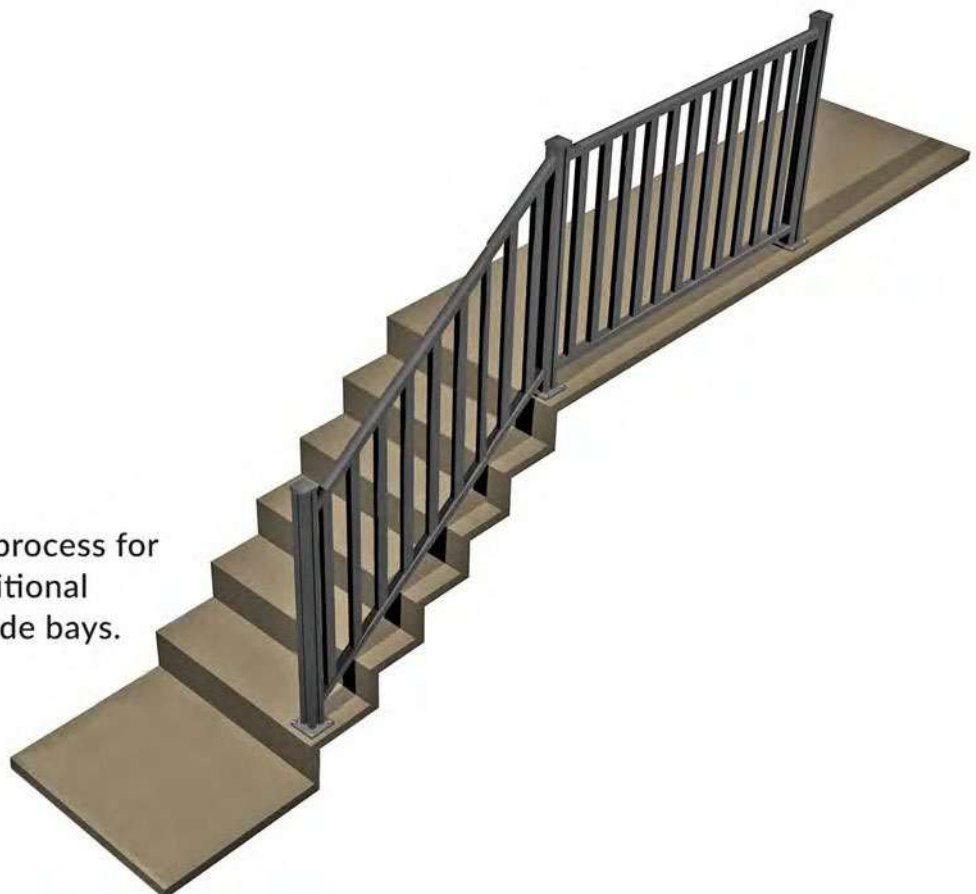

Look out for our FSC® 100% - certified products



The mark of responsible forestry